

BLY17MDA Series 24V, 10A Brushless Controller/Motor

User's Guide

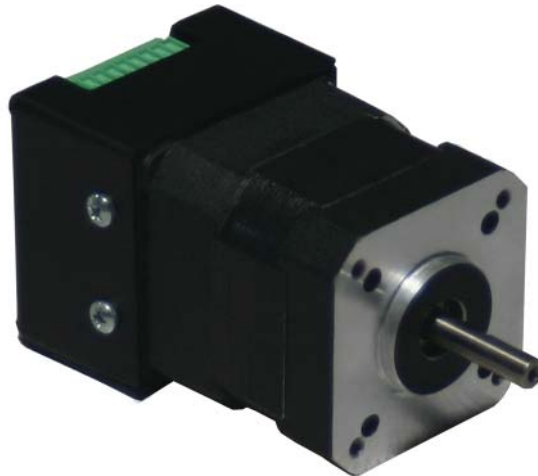

ANAHEIM AUTOMATION

4985 E. Landon Drive Anaheim, CA 92807
e-mail: info@anaheimautomation.com

(714) 992-6990 fax: (714) 992-0471
website: www.anaheimautomation.com

BLY17MDA Driver Features

- Constant Velocity Mode Within 5%
- 400 - 4000 RPM Speed Range
- 0.5V to 5V External Voltage Speed Control
- 2-Quadrant Operation
- Short Circuit Protection
- Maximum Current Limit Setting at 10.0 Amps Peak
- Open Drain Speed Out
- Run/Stop and Direction Inputs
- TTL-CMOS Compatible Inputs
- Compact Size
- Screw Type Terminal Block

General Description

The BLY17MDA is a compact construction that implements a DC Brushless controller and a DC Brushless motor in one streamline package. With the two parts combined into one casing, the need to wire up the motor has been eliminated. The DC Brushless controller operates off 24VDC. The high-speed DC Brushless motor can operate at 4000RPM, can generate up to 35.4oz-in of continuous torque, and deliver as much as 105W, with the BLY17MDA4 offering. Using hall sensor feedback, the DC Brushless controller operates in a constant velocity mode within 5%. The driver is protected against over current (cycle-by-cycle), hall sensor error and under voltage. An external potentiometer (10K) or external voltage (0.5-5VDC) can be used to control the speed. The direction of the motor can be preset by the direction control input. A brake function can be done by grounding the Run/Stop input.

Fault Protection

A cycle-by-cycle over current protection is provided when the motor current level exceeding the current limit of 10A peak is produced. When the over current protection is activated, the controller shuts off the outputs to the motor.

Closed Loop (Constant Velocity Mode)

The driver is set for Closed Loop operation. Closed Loop operation is used for applications where speed regulation is needed. Under closed loop operation, the speed is regulated despite changes to the load and the power supply voltage.

Suggested Power Supplies

Part #	Description
PSA24V2.7A	DC Power Supply 24VDC at 2.7 Amps

Specifications

Direction Input: (TB1, Pin 1)

TTL-CMOS Compatible

Logic "0" = 0 - 0.8VDC

Logic "1" = OPEN

The Direction Input is pulled up through a 10k ohm resistor.

Run/Stop Input: (TB1, Pin 2)

TTL-CMOS Compatible

Logic "0" = 0 - 0.8VDC, Motor Stopped

Logic "1" = OPEN

The Run/Stop Input is pulled up through a 10k ohm resistor.

V Speed: (TB1, Pin 3)

To control the speed of the motor with an external DC voltage, a voltage from 0.5VDC (min) - 5VDC (max) must be applied with reference to AGND (TB1, Pin 5).

Control Inputs:

PG Output (TB1, Pin 4):

An open drain signal pulse out is available at a rate of 4 pulses for 1 revolution. The maximum rating for the open drain output is 30VDC/50mA.

$RPM = 15 * PG\ OUT$ (in Hz)

Output Current Rating:

10.0 Amperes peak per phase maximum operating current

(5.0 amperes average per phase maximum operation current)

Power Requirements: (TB1, Pins 8 and 9)

18VDC (min) - 36VDC (max)

Operating Temperature:

Heat Sink: 0° - 70°C

Motor Run/Stop

The motor run/stop feature allows the stopping of a motor by shorting out the bottom drives of the three phases. A low at this input allows the motor to STOP, while a high (open) input allows the motor to RUN. A low signal will cause rapid deceleration.

Motor Direction

The motor direction feature allows the changing of the rotation of the motor. This input should not be changed while motion is in progress. A high (open) input causes the motor to turn in the CW direction, while a low at this input causes the motor to turn in the CCW direction.

Speed Output

The PG OUT Terminal (TB1 - Pin 4) is used to determine the speed of the motor shaft. This is an open drain output.

RPM

$15 * PG\ Out$ (in Hz)

Speed Adjust Setting

An external voltage is used to control the speed of the motor. The 0.5 - 5VDC analog voltage can be tied on VSPD (TB1 - Pin 3) with respect to AGND (TB1 - Pin 5). A ramp up profile at start up on VSPD (TB1 - Pin 3) would alleviate excessive current draw from the power supply. When the motor is rapidly accelerated from standstill, current drawn from the power supply can measure up to ten times the rated motor current. This startup current spike can shutdown power supplies by tripping the power supply's current limit.

A ramp down profile from max operating speeds would alleviate any back EMF generated. When the motor is rapidly decelerated or stopped from high speed, the motor phase advances and this "returned energy" voltage appears on the drive's power supply pins. Returned energy voltages seen at the input pins in excess of 50V will change the driver.

The maximum ramp times are determined per application. Both the ramp up and ramp down speed profiles would need to be done with an external controller.

The maximum voltage that can be place on VSPD is 10V. A voltage exceeding 10V will cause damage to the driver. If a voltage other than 0.5V to 5V is needed to control the speed of the motor, contact Anaheim Automation for custom tuning of the VSPD input.

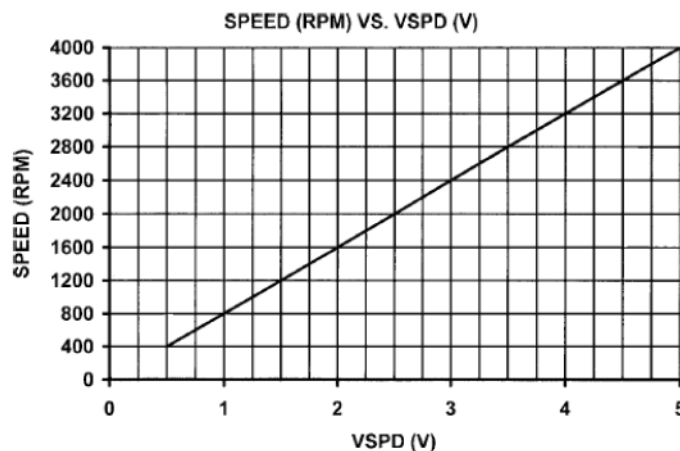

Note: Avoid changing the direction of rotation when the motor is already running in any one direction.

The following instructions must be followed to prevent permanent drive failure due to over-current conditions that exist in dynamic direction reversals of the motor:

1. Stop the motor by grounding the Run/Stop input
2. Wait for a least 500mS
3. Change the direction with the DIRECTION input
4. Run the motor by removing ground signal on the Run/Stop input

Heating Considerations

The temperature of the motor should never be allowed to rise above 70° Celsius. If necessary, mount the unit to an additional heat sink or air should be blown across the heat sink to maintain suitable temperatures.

Dimensions and Ratings

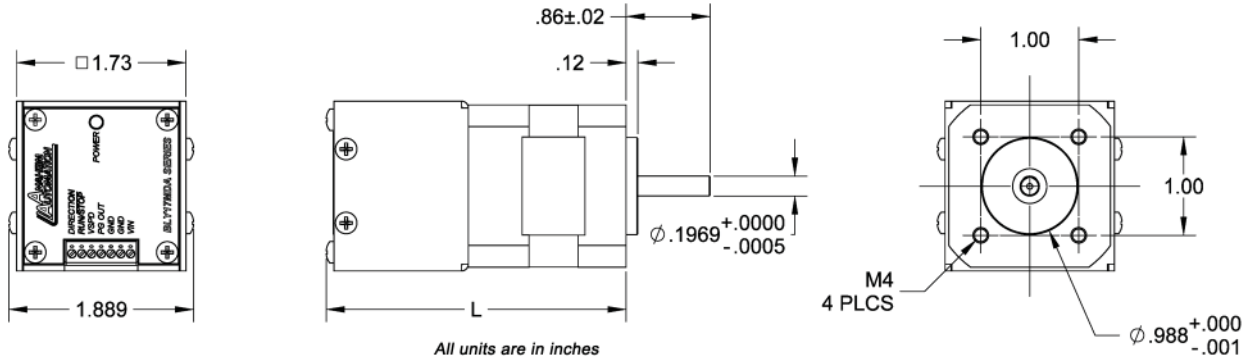

Model	L (in)	Torque (oz-in)	Power (W)	Current (A)
BLY17MDA1	2.975	8.9	26.2	1.1
BLY17MDA2	3.775	17.7	52.4	2.2
BLY17MDA3	4.575	26.2	77.6	3.3
BLY17MDA4	5.275	35.4	104.8	4.4

Terminal Block Descriptions

Pin #	Description
1	Direction
2	Run/Stop
3	Vspeed
4	PG OUT
5	AGND
6	PGND
7	VIN

TB1: Power In, Control Inputs and Outputs

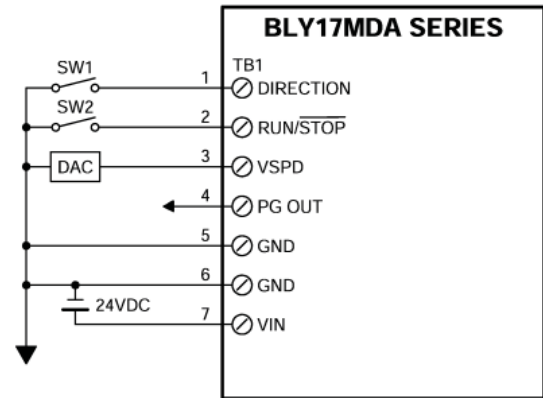

Torque Speed Curve

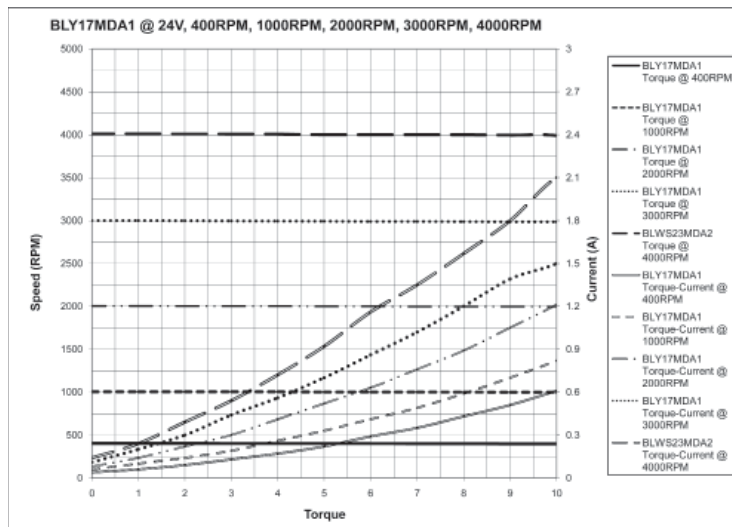

Torque Speed Curve Continued

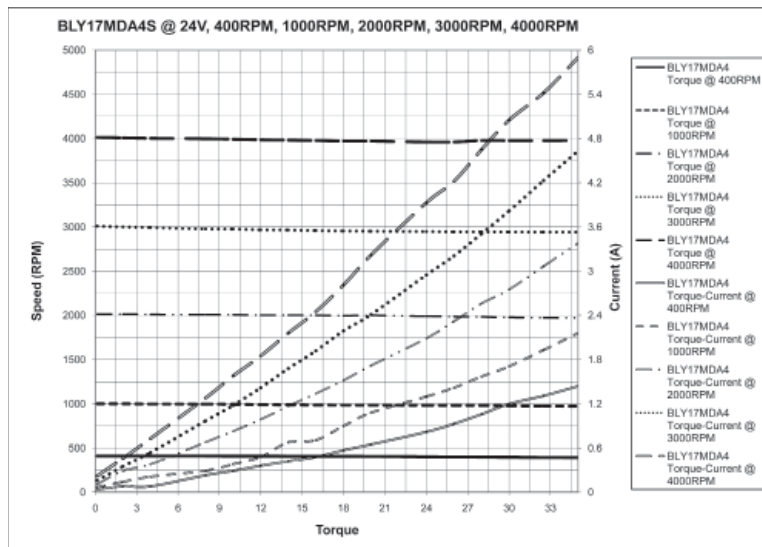
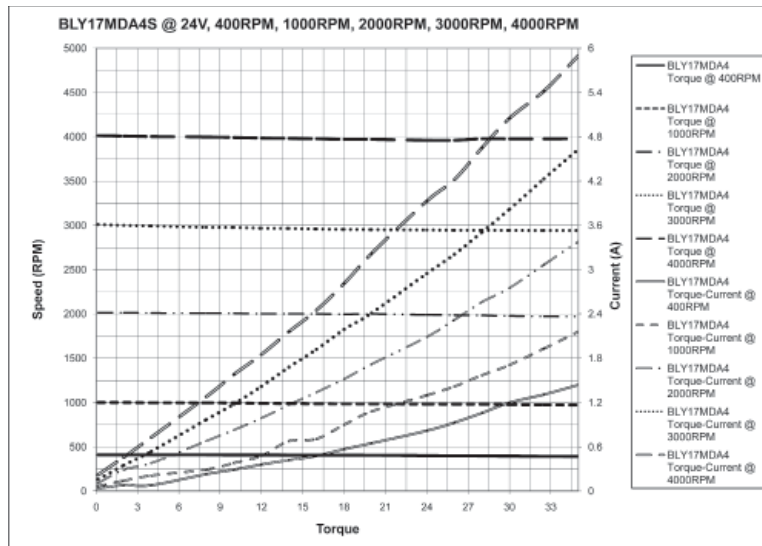
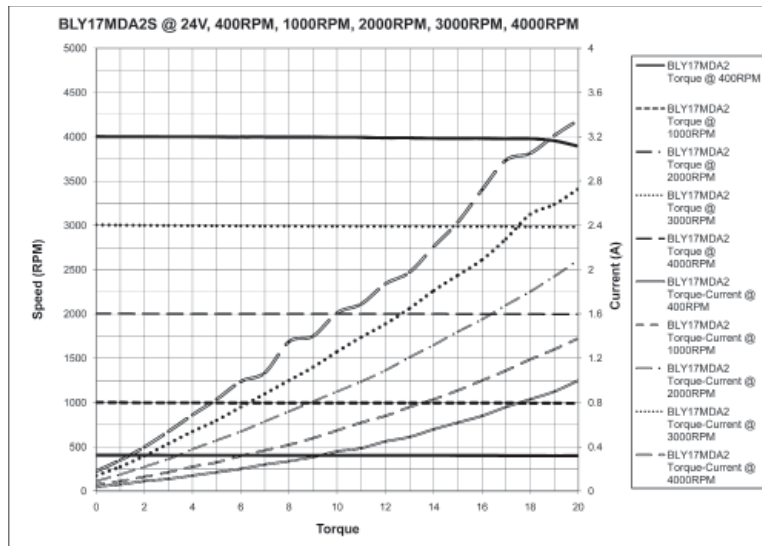

COPYRIGHT

Copyright 2012 by Anaheim Automation. All rights reserved. No part of this publication may be reproduced, transmitted, transcribed, stored in a retrieval system, or translated into any language, in any form or by any means, electronic, mechanical, magnetic, optical, chemical, manual, or otherwise, without the prior written permission of Anaheim Automation, 4985 E Landon Drive, Anaheim, CA 92807.

DISCLAIMER

Though every effort has been made to supply complete and accurate information in this manual, the contents are subject to change without notice or obligation to inform the buyer. **In no event will Anaheim Automation be liable for direct, indirect, special, incidental, or consequential damages arising out of the use or inability to use the product or documentation.**

Anaheim Automation's general policy does not recommend the use of its' products in life support applications wherein a failure or malfunction of the product may directly threaten life or injury. Per Anaheim Automation's Terms and Conditions, the user of Anaheim Automation products in life support applications assumes all risks of such use and indemnifies Anaheim Automation against all damages.

LIMITED WARRANTY

All Anaheim Automation products are warranted against defects in workmanship, materials and construction, when used under Normal Operating Conditions and when used in accordance with specifications. This warranty shall be in effect for a period of twelve months from the date of purchase or eighteen months from the date of manufacture, whichever comes first. **Warranty provisions may be voided if products are subjected to physical modifications, damage, abuse, or misuse.**

Anaheim Automation will repair or replace at its' option, any product which has been found to be defective and is within the warranty period, provided that the item is shipped freight prepaid, with previous authorization (RMA#) to Anaheim Automation's plant in Anaheim, California.

TECHNICAL SUPPORT

If you should require technical support or if you have problems using any of the equipment covered by this manual, please read the manual completely to see if it will answer the questions you have. If you need assistance beyond what this manual can provide, contact your Local Distributor where you purchased the unit, or contact the factory direct.

ANAHEIM AUTOMATION