

BLY17MDA-2W Integrated BLDC Motor/Controller Series



FEATURES

- Open Loop Velocity Mode
- 4000 RPM Rated Speed Range
- 6200 RPM No-load Speed Range
- 2-Quadrant Operation
- Requires 18-24VDC
- Short Circuit Protection
- Maximum Current Limit Setting Fixed at 10.0 Amps Peak
- Direction Input
- Compact Size
- Motor Frame: 1.7" Square



DESCRIPTION

The BLY17MDA-2W Series is a compact construction that implements a DC Brushless controller and a DC Brushless motor in one streamline package in a 2 wire system, only requiring a power and ground input. With the two part combined into one casing, the need to wire the motor has been eliminated. The DC Brushless controller operates off 24VDC. The high-speed DC Brushless motor can operate at a rated speed of 4000RPM, a no-load speed of 6200RPM can generate up to 35.4 oz-in of continuous torque, and deliver as much as 105W, with the BLY17MDA4 offering. The direction of the motor can be preset by the direction control input. A high (24VDC) input causes the motor to turn in the CW direction, while a low (0VDC) at this input causes the motor to turn in the CCW direction. Similar to a Brushed DC motor the speed is varied by the input voltage. ****Other voltage and speed options are available, please contact Anaheim Automation directly for more information. ****

DIMENSIONS & ORDERING INFO

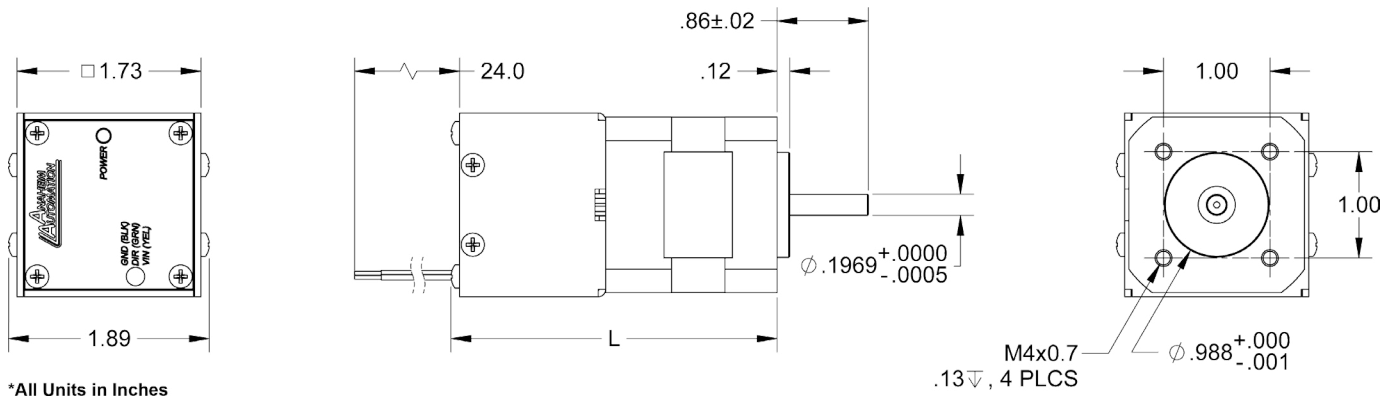

Model #	No Load Speed (RPM)	Rated Speed (RPM)	Torque (oz-in/A)	Rated Power (W)	"L" Length (in)
BLY17MDA1S-24V-4000-2W	6200	4000	4.8	26	2.975
BLY17MDA2S-24V-4000-2W	6200	4000	5.8	52	3.775
BLY17MDA3S-24V-4000-2W	6200	4000	5.4	78	4.575
BLY17MDA4S-24V-4000-2W	6200	4000	5.0	104	5.275

L011085

Wire Descriptions

Wire Colors	Description
Green	Direction
Yellow	Vin (24VDC)
Black	GND (0VDC)

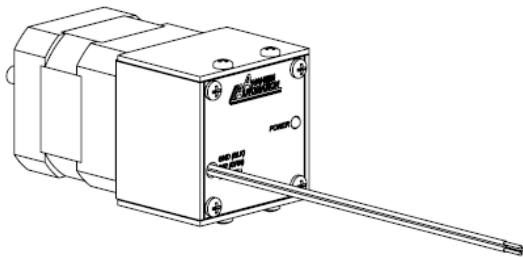

Hook Up Diagram

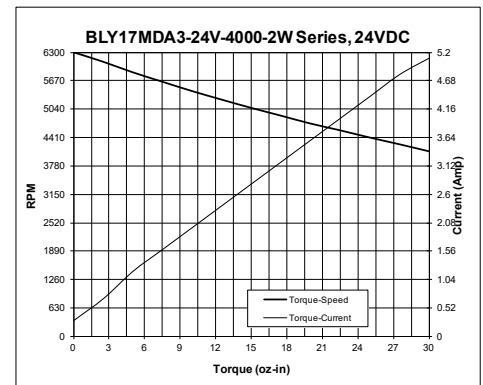
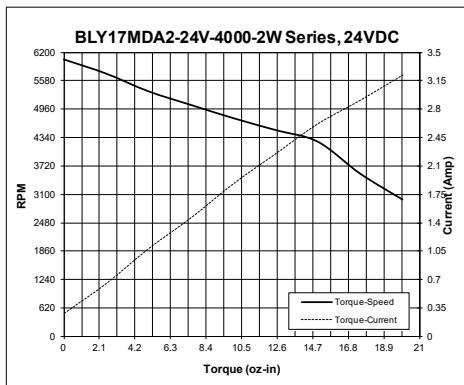
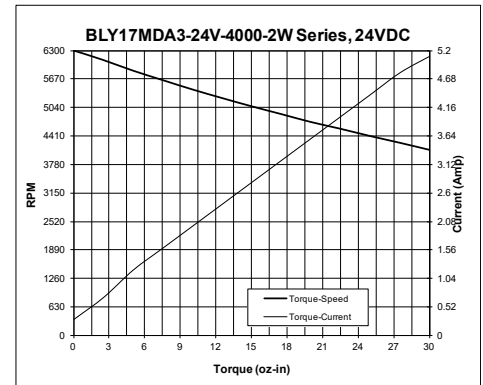
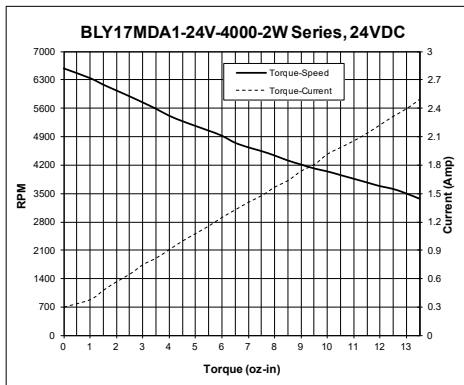
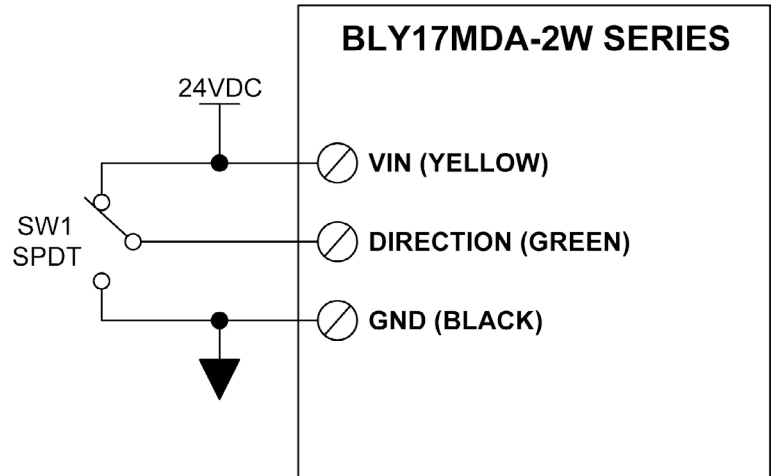

Winding Type:	Delta, 8 Poles	Max Radial Force:	6.29 lbs. @ 10mm from Flange
Hall Effect Angle:	120 Degree Electrical Angle	Max Axial Force:	2.25lbs - Force
Shaft Run Out:	0.025mm	Insulation Class:	Class B
Radial Play:	0.02mm@450g	Dielectric Strength:	500VDC for one minute
End Play:	0.08mm@450g	Insulation Resistance:	100Mohm
Humidity Range:	75% (RH) non-condensing	Operating Temp. Range:	0 - 45 degrees C