

PKG-343-MBC12-PS-CBL

System Diagram and Specifications

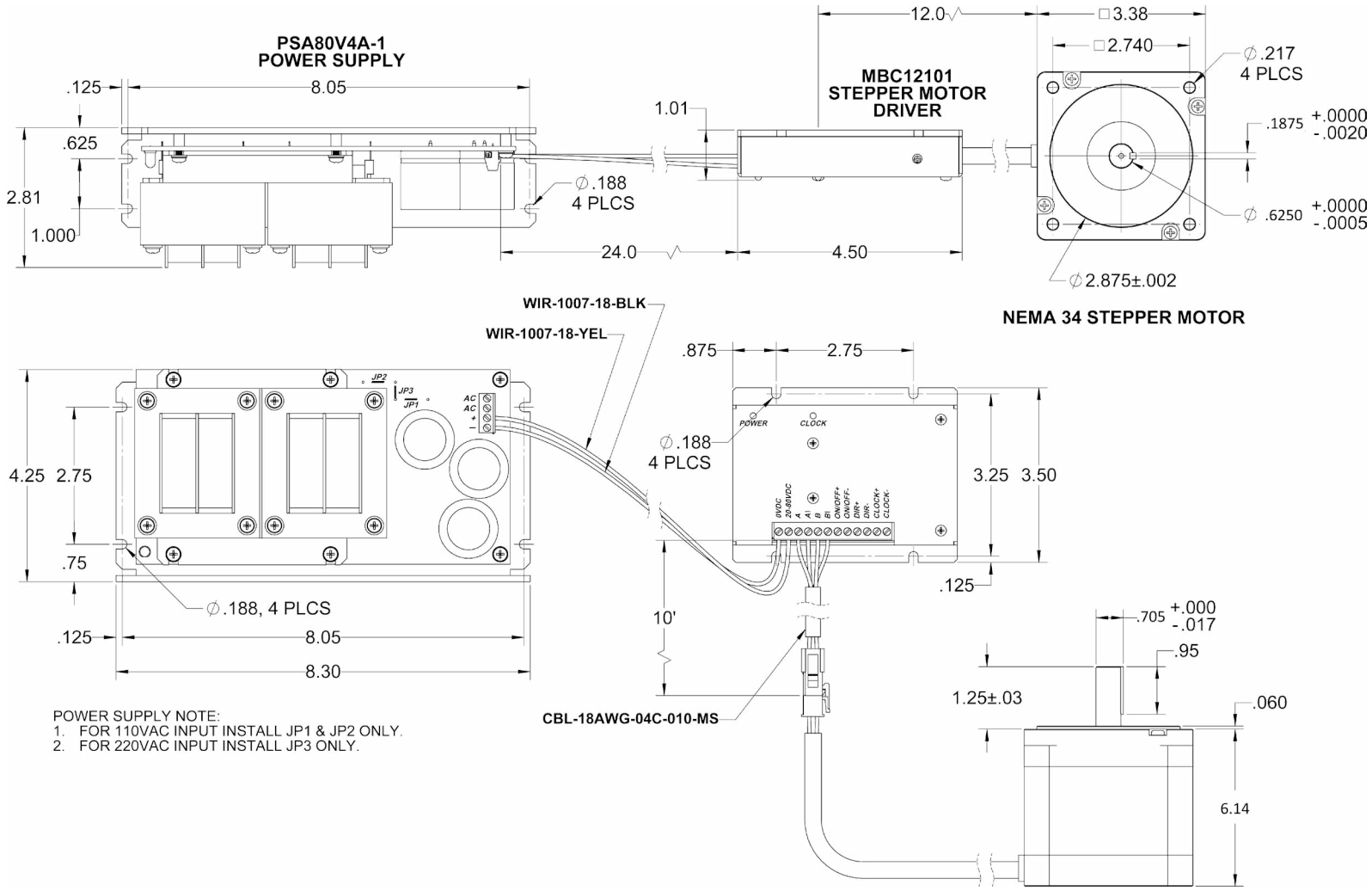

Included Components:	
34Y314S-LW8-MS	Stepper Motor
MBC12101	Stepper Driver
PSA80V4A-1	Power Supply
CBL-18AWG-04C-010-MS	Motor Cable
WIR-1007-18-YEL	Power Wire
WIR-1007-18-BLK	Power Wire

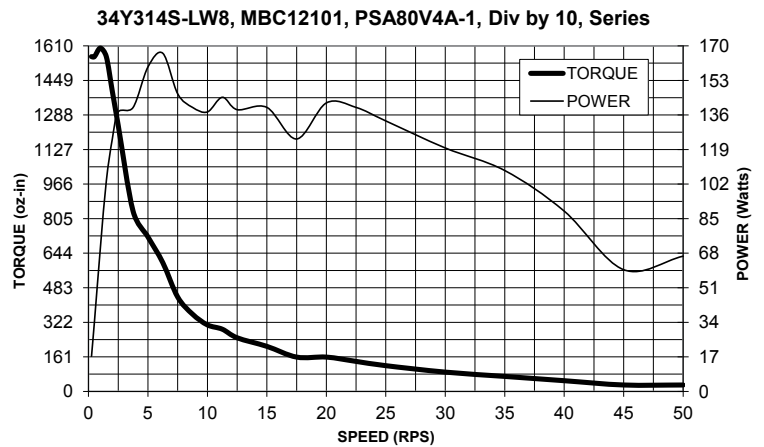

L010873

34Y314S-LW8-MS - High Torque Stepper Motor



FEATURES

- **NEMA 34 Frame Size**
- **Holding Torque - 1,700 oz-in**
- **1.8° Step Angle**
- **High Step Accuracy and Resolution**
- **Low Vibration and Noise**
- **CE Certified RoHS Compliant**



The 34Y314S-LW8-MS High Torque Stepper Motor offers a great value without sacrificing quality. This motor was designed to offer the highest possible torque while minimizing vibration and audible noise. It is wired in series with a Molex 4 pin Mini-Fit Jr. receptacle.

A 10 ft. 4 conductor, 18 AWG cable with mating 4 pin Mini-Fit Jr plug is included in the PKG-343-MBC12-PS-CBL stepper/motor package.

SPECIFICATIONS/DIMENSIONS

Model #	NEMA Size	Holding Torque (oz-in)	Bipolar Current (A)	Bipolar Resistance (ohms)	Bipolar Voltage (v)	Bipolar Inductance (mH)	Rotor Inertia (oz-in-sec ²)	Shaft Diameter (in)	Weight (lbs)	Length (in)
34Y314S-LW8-MS	34	1700	5.0	1.12	5.6	14.2	0.0566	0.625	11.9	6.14

Step Angle Accuracy:	± 5% (Full Step, No Load)	Insulation Resistance:	100M Ohm Min, 500VDC
Resistance Accuracy:	± 10%	Dielectric Strength:	500VDC for 1 minute
Inductance Accuracy:	± 20%	Shaft Radial Play:	0.02" Max (1.0 lbs)
Temperature Rise:	80°C Max (2 Phases On)	End Play:	0.08" Max (1.0 lbs)
Ambient Temperature:	-20° to +50° C	Max Radial Force:	49.5 lbs (0.79" from flange)
Insulation Type:	Class B	Max Axial Force:	13.5 lbs-Force

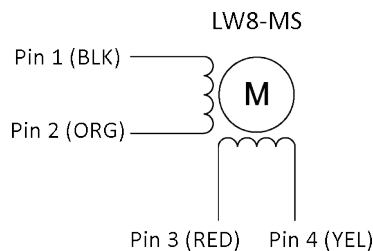

Pin #	Lead Wire Connection	Lead Wire Color
1	Phase 1 (A)	Black
2	Phase 3 (A)	Orange
3	Phase 2 (B)	Red
4	Phase 4 (B)	Yellow
	Soldered Together	White/Black & White/Orange
	Soldered Together	White/Red & White/Yellow

MBC12101 - Microstep Driver



FEATURES

- Compact Stepper Motor Driver
- 1.5 - 10.0 Amp Current Range
- 2000 Steps per Revolution
- Optically Isolated Inputs
- Short Circuit Protection
- 20 - 80VDC Bus Voltage
- Automatic Current Reduction
- Sinking and Sourcing Inputs
- Power and Clock LEDs
- CE Certified and RoHS Compliant



DESCRIPTION

If you're looking for high performance in a small driver, the MBC12101 is your answer. This powerful microstepping driver provides excellent torque in a compact and low profile enclosure. The MBC12101 is also very easy to use. It features rugged terminal blocks, a rotary pot for current settings, and a visible silkscreen for easy installation.

The MBC12101 features optically isolated inputs that are 3.5 - 8.6VDC compatible. The clock input can be set to receive either sinking or sourcing clock signals at frequencies up to 100KHz. The driver also features direction control, motor on/off capabilities, and a built in short circuit and miswire shutdown protection.

The MBC12101 is a bipolar type driver designed for use with 4, 6, or 8 lead stepper motors, making it compatible for series and parallel installations. The driver has a 2000 steps per revolution or 0.18° per step resolution, with respect to a 1.8° stepper motor. It also has a motor current reduction feature that will help keep stepper motors cool at standstill, and LEDs that indicate power and pulses being received.

SPECIFICATIONS

Power Requirements:	20 - 80 VDC
Output Current Range:	1.5 - 10.0 Amps (Peak)
Output Current Range:	1.1-1.7A (RMS)
Microstepping Resolution:	2000 Steps/Revolution (Div-by-10)
Input Signal Voltage:	3.5 - 8.6 VDC
Input Clock Frequency:	0 - 100 kHz
Minimum Input Current: (Isolated Inputs)	1.0 mA
Storage Temperature:	0° - 50° C
Absolute Maximum Driver Temperature:	0-70° C
Chopping Frequency	27-33 kHz

TYPICAL APPLICATION HOOK-UP

SINKING INPUTS:

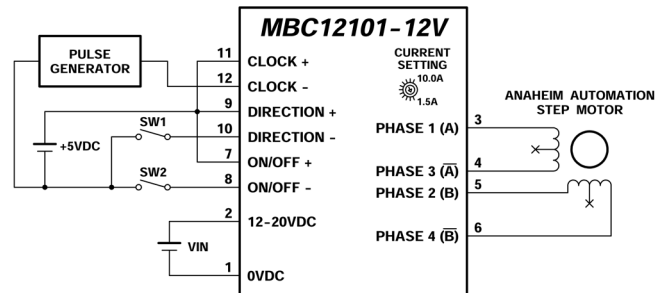

SOURCING INPUTS:

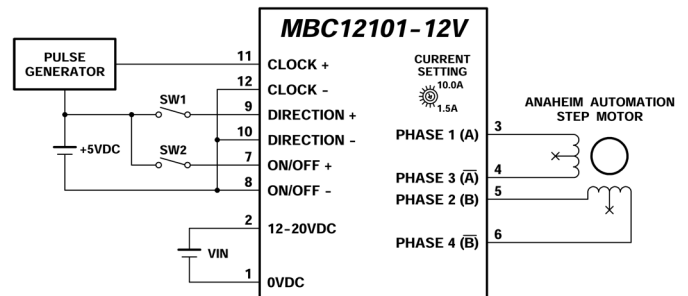

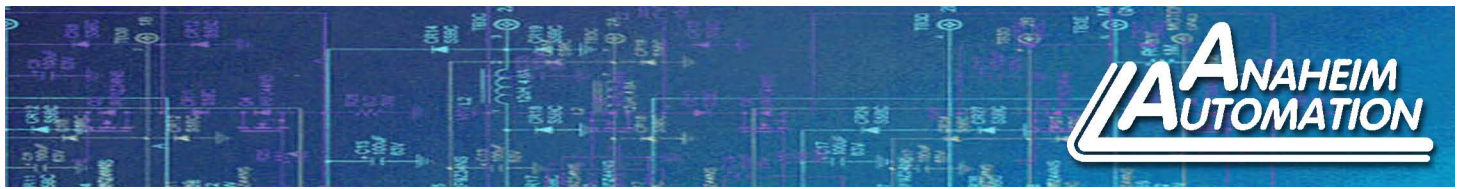

Optically Isolated Input Pin Descriptions

The inputs of the MBC12101 are optically isolated with the anode (+) and cathode (-) both brought out to the user. With no current going through the opto-diode the input is considered high. To enable the input a minimum of 1.0mA needs to be sourced or sunk through the opto-diode. This is done simply by placing a voltage of +3.5 to +8.6 VDC across the two inputs of the opto-diode. If sourcing current into the inputs, then all three cathodes (-) should be tied together and grounded. If sinking current, then all three anodes (+) should be tied together to the +voltage as shown in the TYPICAL APPLICATION HOOK-UP.

To enable an input, apply a DC voltage source of +5VDC to +8.6VDC across the inputs. The Anodes (+) are pins 7, 9, and 11 and the Cathodes (-) are pins 8, 10, and 12.

Connecting the Step Motor

Phase 1 (A) and 3 (A) of the Step Motor is connected between pins 3 and 4 on the terminal block connector. Phase 2 (B) and 4 (B) of the Step Motor is connected between pins 5 and 6 on the terminal block connector.

NOTE: The physical direction of the motor with respect to the direction input will depend on the connection of the motor windings. To reverse the direction of the motor with respect to the direction input, swap the wires on Phase 1 and Phase 3.

WARNING: Do not connect or disconnect motor wires while power is applied! This driver *does not* protect itself if the motor is disconnected while powered.

12 Pin Terminal Block Description

Pin #	Description
1	0VDC: Return path for driver voltage
2	20-80 VDC: Input voltage for the driver (+20-80VDC)
3	A: Phase 1 of the Step Motor
4	A1: Phase 3 of the Step Motor
5	B: Phase 2 of the Step Motor
6	B1: Phase 4 of the Step Motor
7	ON/OFF+: On/Off Anode (+) - This isolated input is used to enable and disable the output section of the driver. When HIGH (open) the outputs are enabled. However, this input does not inhibit the step clock.
8	ON/OFF-: On/Off Cathode (-)
9	Dir+: Direction Anode (+) - This isolated input is used to change the direction of the motor. Physical direction also depends on the connection of the motor windings.
10	DIR-: Direction Cathode (-)
11	CLOCK+: Step Clock Input Anode (+) - A positive going edge on this isolated input advances the motor one increment. The size of the increment is dependent on the Microstep Select Inputs of Switch 1.
12	CLOCK-: Step Clock Input Cathode (-)

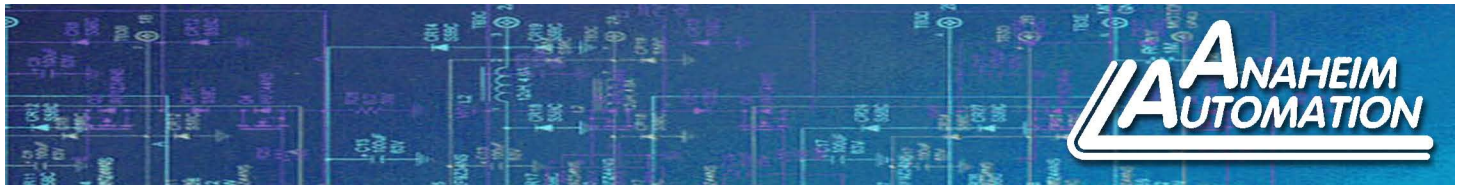

Setting the Output Current:

The output current on the MBC12101 is set by an onboard potentiometer. This potentiometer determines the per phase peak output current of the driver.

The specified motor current of 5.0A for the 34Y314S-LW8-MS (which is the bipolar value) is multiplied by a factor of 1.4 to determine the current adjustment potentiometer value of 7.0Amps or 60%.

Peak Current	Potentiometer Setting	Peak Current	Potentiometer Setting
1.5A	0%	7.0A	60%
2.3A	10%	7.9A	70%
3.0A	20%	8.7A	80%
4.0A	30%	9.6A	90%
5.0A	40%	10A	100%
6.0A	50%	--	--

WARNING: Do not set the current setting above the step motors rated current. When using a higher current setting into a motor, the motor will overheat and burn up. Should this occur, the driver will also be damaged.

Reducing Output Current

Reducing the output current occurs approximately 1 second after the last positive going edge of the step clock input. The amount of current per phase in the reduction mode is approximately 50% of the set current. Reducing the output current is accomplished when no current flows through the opto-diode at the CLOCK (+) and CLOCK (-) pins after the last step has occurred. The clock LED should be off at this time.

PSA80V4A-1 - Power Supply



FEATURES

- **Low Cost**
- **High Reliability**
- **Short Circuit**
- **Overload Protection**



DESCRIPTION

The PSA80V4A-1 power supply has a single 80V output, a voltage input of 115 or 220VAC, and power capabilities of up to 320 watts. With an unregulated output and a size of 8.30" x 4.25" x 2.81" and dual mounting position "L Bracket," the PSA80V4A-1 can be mounted just about anywhere. The PKG-343-MBC12-PS-CBL includes two wires for powering the MBC12101.

DIMENSIONS/SPECIFICATIONS

DC Voltage Output:	80V
Output Rated Current:	4A
Input Voltage Range:	115/220VAC, 60 Hz
Rated Output Power:	320W

