

KNC-SRV-SMC60S-0020 Servo Motor



FEATURES

- 220 VAC
- 200 W Power Rating
- Rated Torque of 90 oz-in
- Maximum Speed of 6000 RPM
- 2500 PPR Incremental Encoder
- IP65 for Body, IP54 Shaft Seal
- 60mm Frame Size
- CE Certified



DESCRIPTION

The KNC-SRV-SMC60S-0020 Series Servo Motor offers a solution to servo applications requiring position and speed control. This servo motor series comes standard with a 2,500 Pulses per Revolution (PPR) Incremental Encoder, runs at a rated speed of 3000 RPM, provides peak values up to 300% of the rated torque and current values, and has a rated torque of 90 oz-in with a 200 Watt power rating. This servo motor series enables industrial motion control applications to attain a great combination of position and speed functionality.

ORDERING INFORMATION

SMC60S - 0020 - 30AAK - 3LKH

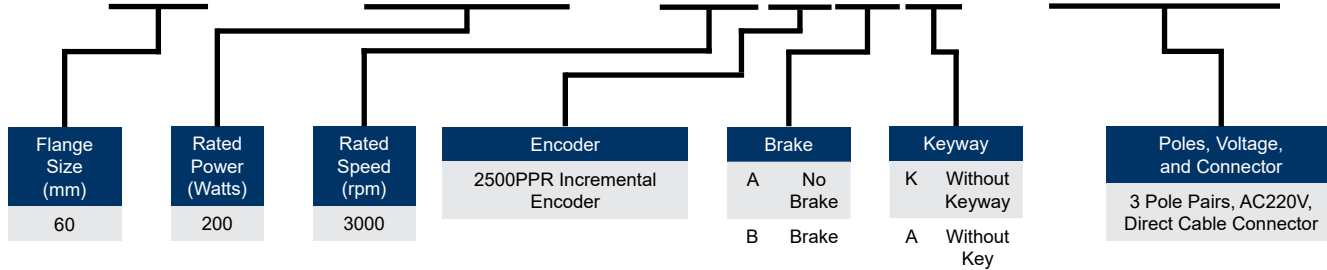

L011650

Model	KNC-SRV-SMC60S-0020-30AAK-3LKH KNC-SRV-SMC60S-0020-30ABK-3LKH
Compatible Driver	KNC-SRV-FD422S-CA-000 KNC-SRV-FD422S-AA-000 KNC-SRV-FD422S-LA-000
DC Link Voltage (VDC)	300
Rated Power (W)	200
Rated Torque (oz-in)	90
Rated Speed (RPM)	3000
Max Speed (RPM)	6000
Rated Current (A)	1.4
Maximum Torque (oz-in)	271
Maximum Current (A)	4.2
Rated Standstill Torque (oz-in)	99
Rated Standstill Current (A)	1.5
Resistance Line-Line (Ω)	11.2
Inductance Line-Line (mH)	20.9
Electrical Time Constant (ms)	1.87
Mechanical Time Constant (ms)	1.8
Torque Constant Kt (oz-in/A)	67.9
Rotor Moment of Inertia Jm (oz-in-s ²)	0.00303 0.00308 (with brake)
Pole Pair Number	3
Maximum Voltage Rising du/dt (KV/ μ s)	8
Insulation Class	F
Maximum Radial Force F (N)	180
Maximum Axial Force F (N)	90
Weight (lbs)	2.42 3.52 (with brake)

KNC-SRV-SMC60S-0020-30AAK-3LKH

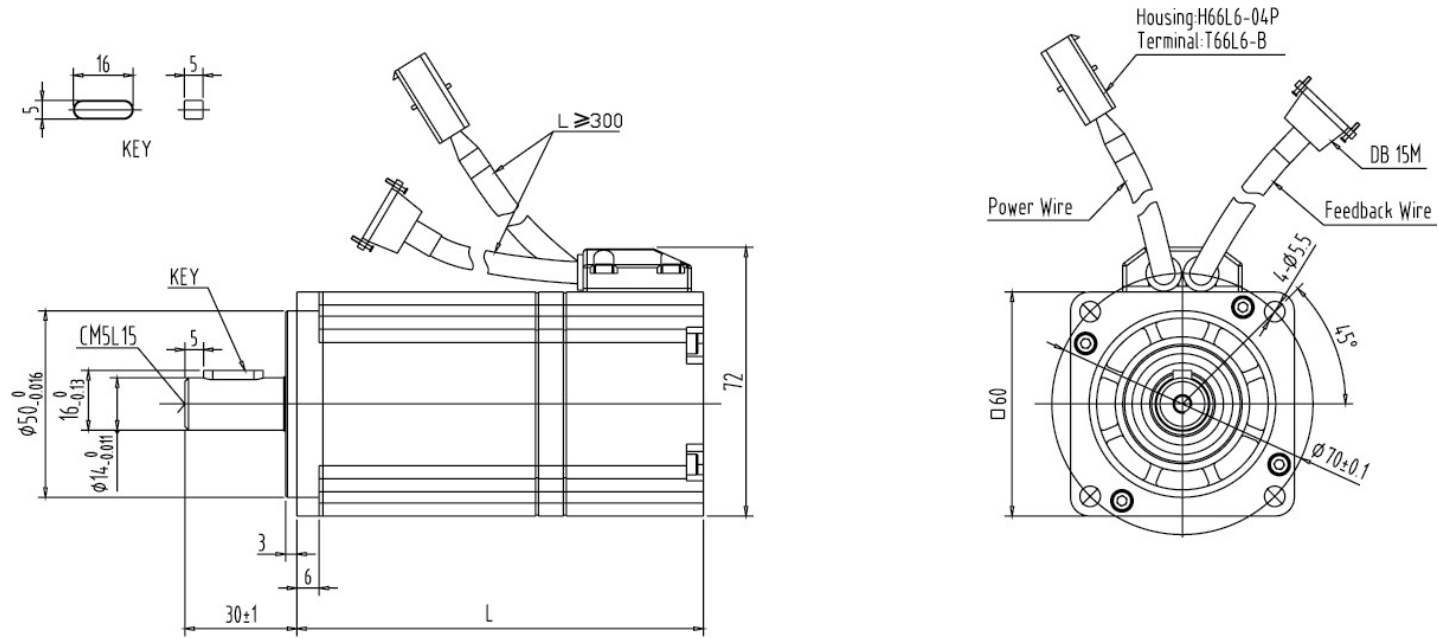

Dimensions are in mm

Model	KNC-SRV-SMC60S-0020-30AAK-3LKH KNC-SRV-SMC60S-0020-30ABK-3LKH
Length of Motor L (mm)	109 ± 1.5 150 ± 1.5 (with brake)

KNC-SRV-SMC60S-0020-30ABK-3LKH

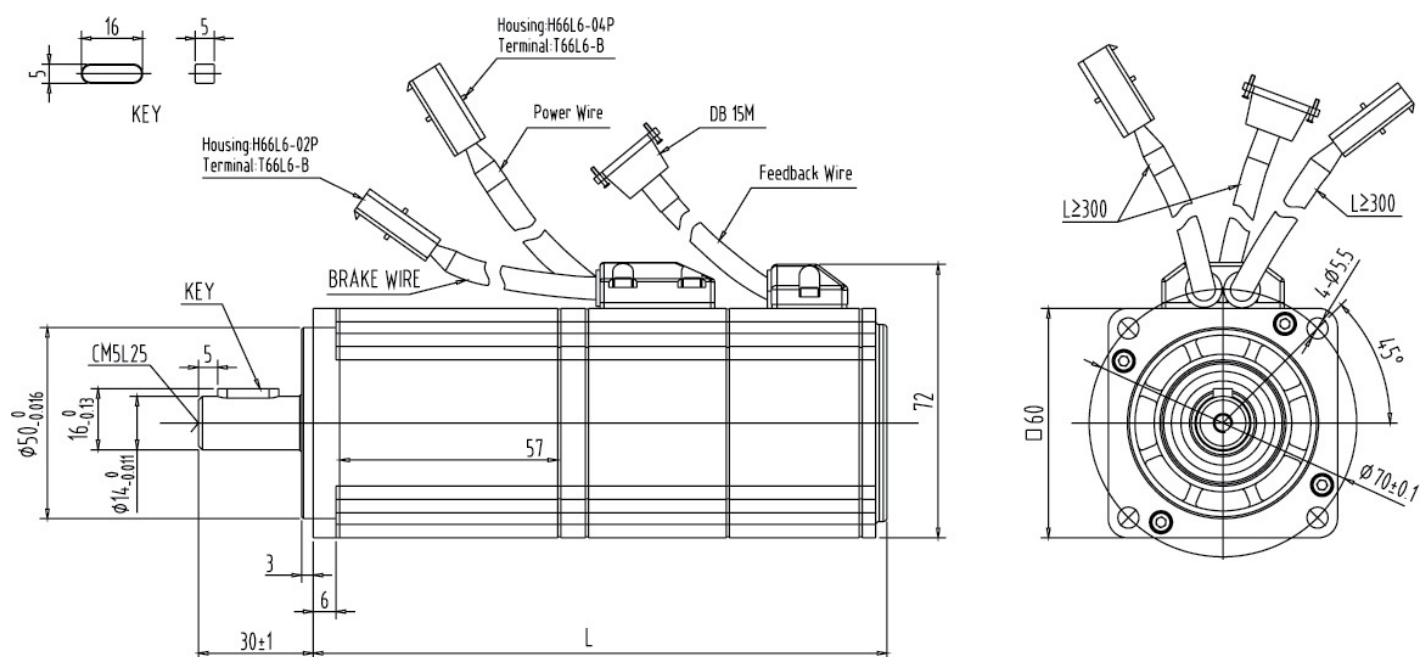

TORQUE CURVE

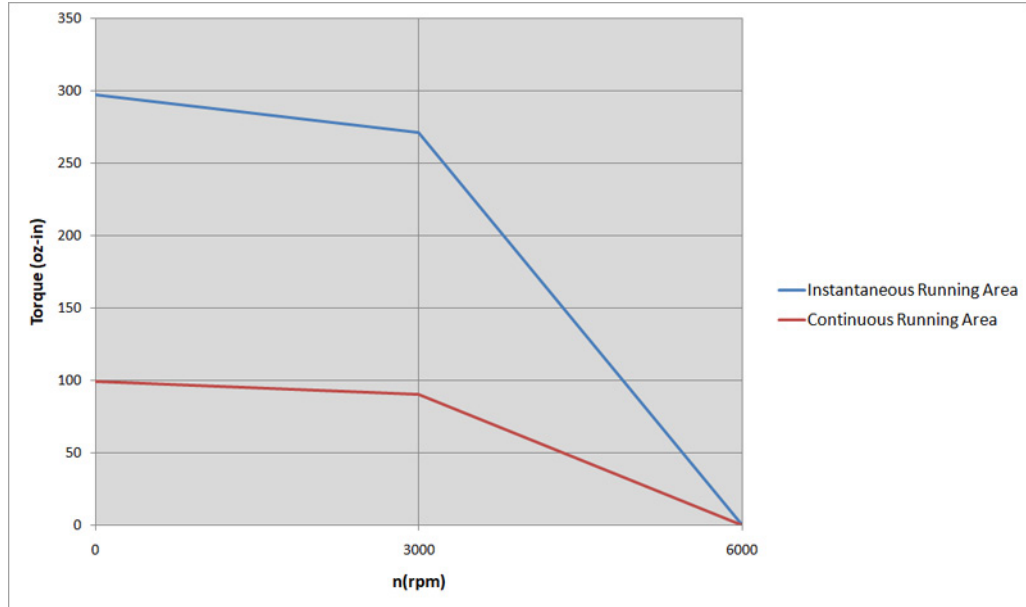

Motor Cable: KNC-SRV-MOT-005-05-KL for KNC-SRV-SMC60S-0020-30AAK-3LKH and KNC-SRV-SMC60S-0020-30ABK-3LKH

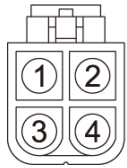

A
4PIN

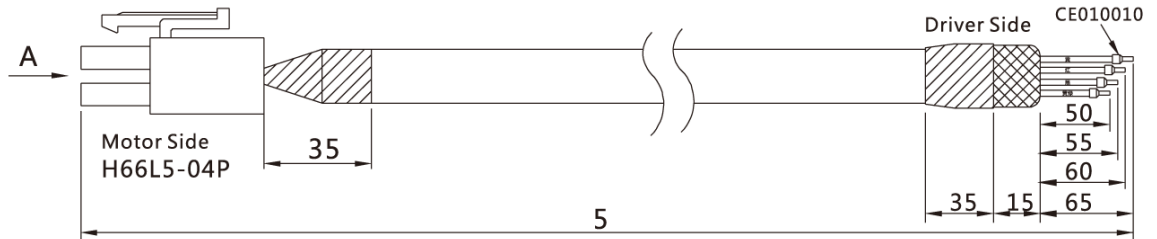

KNC-SRV-MOT-005-05-KL		
Cable Color	Signal	PIN #
Yellow	U	PIN 1
Red	V	PIN 2
Black	W	PIN 3
Yellow-green	PE	PIN 4

Brake Cable: KNC-SRV-BRA-05-KL for KNC-SRV-SMC60S-0020-30ABK-3LKH

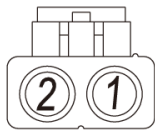

A
2PIN

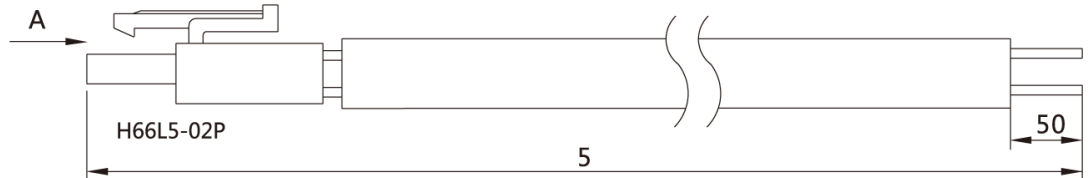

KNC-SRV-BRA-05-KL		
Cable Color	Signal	PIN #
Red	Brake +	PIN 1
Blue	Brake -	PIN 2

WIRING PINOUTS

Encoder Cable: KNC-SRV-ENCCF-05-FH for KNC-SRV-SMC60S-0020-30AAK-3LKH and KNC-SRV-SMC60S-0020-30ABK-3LKH

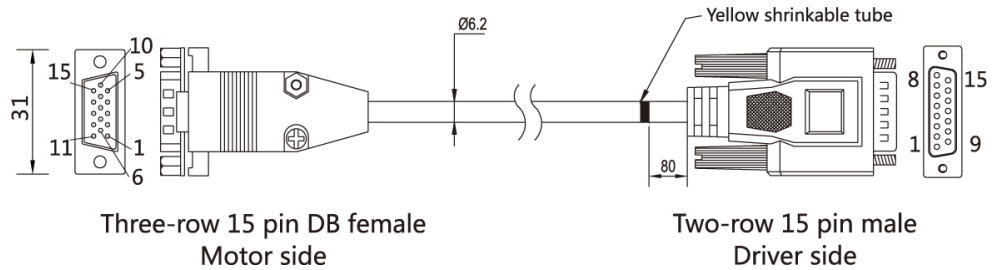

WIRING PINOUTS

KNC-SRV-ENCCF-05-FH				
Three-Row Motor Side 15 PIN DB	Two-Row Driver Side 15 PIN DB	Signal	External Wire Color	Motor Wire Color
PIN 1	PIN 1	+5V	Red (thick)	Red
PIN 8	PIN 2	A	Brown	Blue-Black
PIN 7	PIN 3	B	Yellow	Green
PIN 6	PIN 4	Z	Green	Yellow
PIN 2	PIN 9	GND	Black (thick)	Black
PIN 13	PIN 10	/A	Brown-white	Blue
PIN 12	PIN 11	/B	Yellow-white	Green-black
PIN 11	PIN 12	/Z	Green-white	Yellow-black
Other PINs empty	Other PINs empty	n/a	n/a	n/a
Shell	Shell	Shield	Shield	Shield

SPECIFICATIONS

Model	Motor Cable	Encoder Cable	Brake Cable
KNC-SRV-SMC60S-0020-30AAK-3LKH	KNC-SRV-MOT-005-05-KL	KNC-SRV-ENCCF-05-FH	-
KNC-SRV-SMC60S-0020-30ABK-3LKH			KNC-SRV-BRA-005-05-KL

Model	KNC-SRV-SMC60S-0020-30AAK-3LKH KNC-SRV-SMC60S-0020-30ABK-3LKH	
Length of Motor L(mm)	109 ± 1.5 150 ± 1.5 (with brake)	
Cooling Method	Totally Enclosed, Non-Ventilated	
Protection Level	IP65 for Body, Shaft Sealing IP54	
Environmental Conditions of Operation	Temperature	-20°C~40°C (Non-freezing)
	Humidity	Below 90% RH (Non-condensing)
	Ambient Environment	Away from active gas, combustible gas, oil drops and dust
	Altitude	Maximum Altitude 4000m, Rated Power at 1000m or Below, Above 1000m: Decreasing 1.5% per 100m Rise